

# JENSEN®

DOCKING DIGITAL MUSIC SYSTEM FOR iPod AND iPhone



**USER MANUAL**

**JiMS-125i**

(iPhone/iPod Not Included)

PLEASE READ THIS USER MANUAL COMPLETELY BEFORE OPERATING THIS UNIT  
AND RETAIN THIS BOOKLET FOR FUTURE REFERENCE.

## DEAR JENSEN® CUSTOMER

Selecting fine audio equipment such as the unit you've just purchased is only the start of your musical enjoyment. Now it's time to consider how you can maximize the fun and excitement your equipment offers. This manufacturer and the Electronic Industries Association's Consumer Electronics Group want you to get the most out of your equipment by playing it at a safe level. One that lets the sound come through loud and clear without annoying blaring or distortion and, most importantly, without affecting your sensitive hearing.

Sound can be deceiving. Over time your hearing "comfort level" adapts to higher volumes of sound. So what sounds "normal" can actually be loud and harmful to your hearing. Guard against this by setting your equipment at a safe level BEFORE your hearing adapts.

### **To establish a safe level:**

- Start your volume control at a low setting.
- Slowly increase the sound until you can hear it comfortably and clearly, and without distortion.

### **Once you have established a comfortable sound level:**

- Set the dial and leave it there.

Taking a minute to do this now will help to prevent hearing damage or loss in the future. After all, we want you listening for a lifetime.

### **We Want You Listening For a Lifetime**

Used wisely, your new sound equipment will provide a lifetime of fun and enjoyment. Since hearing damage from loud noise is often undetectable until it is too late, this manufacturer and the Electronic Industries Association's Consumer Electronics Group recommend you avoid prolonged exposure to excessive noise.

### **Customer's Record:**

The serial number of this product is found on its bottom cover. You should note the serial number of this unit in the space provided as a permanent record of your purchase to aid in identification in the event of theft or loss.

**Model Number: JiMS-125i**

**Serial Number: \_\_\_\_\_**

## IMPORTANT SAFETY INSTRUCTIONS

When used in the directed manner, this unit has been designed and manufactured to ensure your personal safety. However, improper use can result in potential electrical shock or fire hazards. Please read all safety and operating instructions carefully before installation and use, and keep these instructions handy for future reference. Take special note of all warnings listed in these instructions and on the unit.

1. Read these instructions – All the safety and operating instructions should be read before the appliance is operated.
2. Keep these instructions – The safety and operating instructions should be kept for future reference.
3. Heed all warnings – All warnings on the appliance and in the operating instructions should be adhered to.
4. Follow all instructions – All operation and use instructions should be followed.
5. Do not use this apparatus near water – The appliance should not be used near water; for example, near a bath tub, washbowl, kitchen sink, laundry tub, in a wet basement, or near a swimming pool.
6. Clean only with dry cloth – The appliance should be cleaned only as recommended by the manufacturer.
7. Do not block any ventilation openings. Install in accordance with the manufacturer's instructions. The appliance should be situated so that its location or position does not interfere with its proper ventilation. For example, the appliance should not be situated on a bed, sofa, rug, or similar surface that may block the ventilation openings; or placed in a built-in installation, such as a bookcase or cabinet that may impede the flow of air through the ventilation openings.
8. Do not install near any heat sources such as radiators, heat registers, stoves, or other apparatus (including amplifiers) that produce heat.
9. Protect the power cord from being walked on or pinched particularly at plugs, convenience receptacles, and the point where they exit from the apparatus.
10. Only use attachments / accessories specified by the manufacturer.
11. Unplug the ac adaptor of this apparatus during when unused for long periods of time.
12. Refer all servicing to qualified service personnel. Servicing is required when the apparatus has been damaged in any way, such as ac adaptor is damaged, liquid has been spilled or objects have fallen into the apparatus, the apparatus has been exposed to rain or moisture, does not operate normally or has been dropped.

13. This appliance shall not be exposed to dripping or splashing water and that no object filled with liquids such as vases shall be placed on the apparatus.
14. Power Sources – The appliance should be connected to a power supply only of the type described in the operating instructions or as marked on the appliance. Do not overload wall outlet.
15. Danger of explosion if battery is incorrectly replaced. Replace only with the same or equivalent type.
16. Do not attempt to dismantle, open or repair this product yourself. If a fault occurs, seek advice from your local qualified service technician or contact the distributor via the telephone number at the back of this instruction manual.
17. Nameplate is located on bottom of the product.

### **IMPORTANT NOTES**

Avoid installing the unit in locations described below:

- Places exposed to direct sunlight or close to heat radiating appliances such as electric heaters.
- Places subject to constant vibration.
- Dusty, humid or moist places.

### **COMPLIANCE WITH FCC**

This device complies with Part 15 of the FCC Rules. Operation is subject to the following two conditions:

- (1) this device may not cause harmful interference, and
- (2) this device must accept any interference received, including interference that may cause undesired operation.

NOTE : This equipment has been tested and found to comply with the limits for a Class B digital device, pursuant to Part 15 of the FCC Rules. These limits are designed to provide reasonable protection against harmful interference in a residential installation. This equipment generates, uses and can radiate radio frequency energy and, if not installed and used in accordance with the instructions, may cause harmful interference to radio communications. However, there is no guarantee that interference will not occur in a particular installation. If this equipment does cause harmful interference to radio or television reception, which can be determined by turning the equipment off and on, the user is encouraged to try to correct the interference by one or more of the following measures:

- Reorient or relocate the receiving antenna.
- Increase the separation between the equipment and receiver.
- Connect the equipment into an outlet on a circuit different from that to which the receiver is connected.
- Consult the dealer or an experienced radio/TV technician for help.

**CAUTION: Changes or modifications not expressly approved by the party responsible for compliance could void the user's authority to operate the equipment.**

## **Protect Your Furniture**

This product is equipped with non-skid rubber 'feet' to prevent the product from moving when you operate the controls. These 'feet' are made from non-migrating rubber material specially formulated to avoid leaving any marks or stains on your furniture. However certain types of oil based furniture polishes, wood preservatives, or cleaning sprays may cause the rubber 'feet' to soften, and leave marks or a rubber residue on the furniture. To prevent any damage to your furniture we strongly recommend that you purchase small self-adhesive felt pads, available at hardware stores and home improvement centers everywhere, and apply these pads to the bottom of the rubber 'feet' before you place the product on fine wooden furniture.

## LOCATION OF CONTROLS

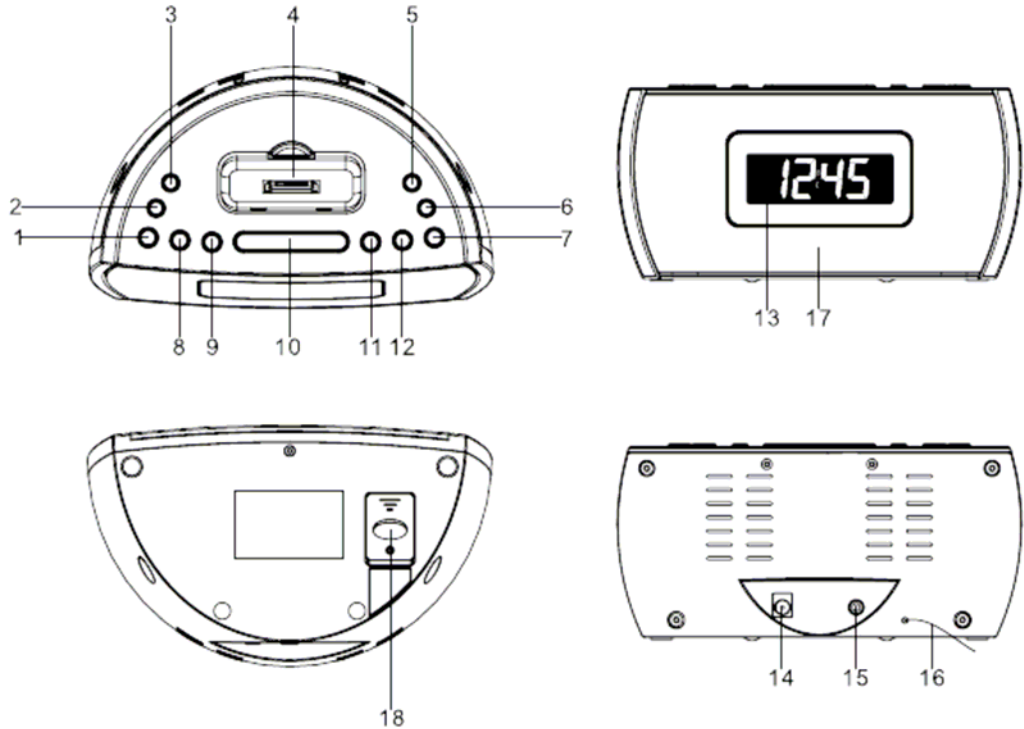

1. POWER On/Standby button
2. MEMORY SET/CLOCK ADJUST button
3. ALARM 1 button
4. iPhone/iPod docking connector
5. ALARM 2 button
6. FUNCTION button
7. SKIP FORWARD / TUNING UP button
8. VOLUME- (DOWN) button
9. VOLUME+ (UP) button
10. SNOOZE/SLEEP/DIMMER button
11. SKIP BACK / TUNING DOWN button
12. iPod PLAY/PAUSE / FM Memory Up button
13. Display
14. DC IN Jack
15. AUX IN Jack
16. FM Wire Antenna (back of unit)
17. Battery Compartment (bottom of unit)

## GETTING STARTED

### Clock Back-up Battery Installation

1. Remove the screw from the BATTERY COMPARTMENT COVER and remove the cover.
2. Install a CR2032 lithium battery (not included) in the battery compartment following the polarity markings shown on it.
3. Replace the BATTERY COMPARTMENT COVER and tighten the screw to secure the compartment.

**Note:** The unit will still operate without the battery installed, but the time, alarm and radio preset settings will be lost and have to be reset in the event of a power interruption or failure.

### **WARNING:**

- Be sure that the battery is installed correctly. Wrong polarity may damage the unit.
- If the unit is not to be used for an extended period of time, remove the battery. Any old or leaking battery can cause damage to the unit and may void the warranty.
- Do not dispose of battery in fire, battery may explode or leak.
- Do not try to recharge a battery that is not intended to be recharged; the battery can overheat, rupture and leak (Follow the battery manufacturer's directions).

### AC-DC Adaptor Connection

An AC-DC Adaptor with the output 5V DC 2000mA (included) is required for operating the main unit. To connect the AC-DC Adaptor to the unit and AC Outlet:

1. Firmly and securely insert the DC plug of the adaptor to the DC jack on the back of the unit.
2. Plug the adaptor's AC plugs into an AC outlet.

**NOTE:** This unit is not magnetically shielded and may cause color distortion on the screen of some TVs or video monitors. To avoid this, you may need to move the unit further away from the TV or monitor if unnatural color shifts or image distortion occurs.

## CLOCK SETTING

### **TO SET THE TIME USING iPhone / iPod TIME SYNC**

After plugging in the AC adaptor power, "12:00" will appear and start blinking in the LCD Panel. If you have an iPod or iPhone with the correct time showing, you can dock it securely into the Docking Bay to take advantage of Automatic Time Sync.

Note: older iPod models such as iPod mini do not support this feature.

1. When "12:00" is flashing on the LCD Display after the initial power connection, insert your iPod/iPhone onto the connector in the docking bay.

2. Your iPod/iPhone will communicate with the unit and automatically sync the time with your iPod/iPhone time and show it on the LCD Display after about 5 seconds.

**Tips:**

- The iPhone receives constant updates from the phone service provider, so the iPhone time will always be accurate.
- The time on your iPod was undated with your computer the last time the iPod was attached and synced with it. We recommend you to calibrate your computer's system clock and sync your iPod with iTunes right before docking into the unit to make sure the current time is accurate.
- The Automatic Time Sync does not support earlier iPod models, like iPod mini and iPod photo (4G/color display)
- When first docked, the iPod/iPhone will run an authentication process internally, so it may not respond to any keys when pressed.
- A 59 second difference between the clock on the unit and the synced iPod/iPhone is possible.

If you need to change the time after using the automatic time sync, you will have to do it manually.

**TO SET THE TIME MANUALLY**

1. In Standby mode, press and hold the MEM.SET/CLK.ADJ. button of the unit, "12 Hr" will blink.
2. Press the ◀◀ or ▶▶ button to set the unit to the 24-hour mode or 12-hour mode.
3. Press the MEM.SET/CLK.ADJ. button then the hour digits will blink.
4. Press the ◀◀ or ▶▶ button to adjust the hour. Press and hold the button for fast advance / reverse setting.  
**Note:** Make sure the hour is set so that the **PM** indicator is displayed correctly.
5. Press the MEM.SET/CLK.ADJ. button to confirm the hour setting, the minute digits will flash to prompt for input.
6. Press the ◀◀ or ▶▶ button to adjust the minute. Press and hold the button for fast advance / reverse setting.
7. Press the MEM.SET/CLK.ADJ. button again to complete the setting.

**ALARM SETTING**

1. In Standby mode, press the ALARM 1 or ALARM 2 button once to check the alarm time and wake up option (iPod, Beep Alarm, Radio).
2. Hold the ALARM 1 or ALARM 2 button for 3 seconds when the alarm time is showing. The hour digits will blink.
3. Press the ◀◀ or ▶▶ button to adjust the hour. Press and hold the button for fast advance / reverse setting.
4. Press the ALARM 1 or ALARM 2 button to confirm the hour setting, the minute digits will flash to prompt for input.



5. Press the ⏮ or ⏭ button to adjust the minute. Press and hold the button for fast advance / reverse setting.
6. Press the ALARM 1 or ALARM 2 button to confirm the minute setting, the alarm sound icons will flash.
7. Press the ⏮ or ⏭ button to select the wake up option (iPod, Beep, Radio).
8. Press the ALARM 1 or ALARM 2 button again to complete the alarm setting. The alarm indicator ① or ② will appear to indicate it is enabled.
9. To disable the alarm, press and hold the ALARM 1 or ALARM 2 button until the alarm indicator ① or ② disappears.

**Note:**

- The alarm will automatically switch to the beep alarm if you selected wake to iPod/iPhone but do not have an iPod or iPhone docked,
- If you select wake to Radio, ensuring a desired radio station is tuned to a radio station. The unit will play the last radio band and station you listen to when the wake time is reached.
- The unit features a crescendo wake up for the beep alarm, radio or iPod/iPhone. When the alarm time is reached, the sound will increase gradually from a very low level and increase to a louder level. For radio and iPod/iPhone wake-up, the preset volume level will be the loudest level. It will reach after about 120 seconds.

**Wake to Radio**

- The Radio will automatically turn on when the alarm time is reached. The respective ① or ② indicator will blink.
- It starts softly and gradually becomes louder until preset volume level is reached.
- The radio alarm will sound for 60 minutes and then turn off automatically if no snooze button pressed.
- To stop the radio sound immediately, tap the ⏻ button.

**Wake to Beep Alarm**



- The Beep Alarm will automatically turn on when the alarm time is reached. The respective ① or ② indicator will blink.
- It starts softly and gradually becomes louder and louder until its maximum level is reached.
- The beep alarm will sound for 60 minutes and then turn off automatically if no snooze button pressed.
- To stop the beep alarm sound immediately, tap the ⏻ button.

**Wake to iPod / iPhone**





- The docked iPod / iPhone will automatically turn on when the alarm time is reached. The respective ① or ② indicator will blink.
- It starts softly and gradually becomes louder until preset volume level is reached.

- The iPod / iPhone alarm will sound for 60 minutes and then turn off automatically if no snooze button pressed.
- To stop the iPod / iPhone sound immediately, tap the  button.

### **Snooze Function**

- When the alarm sounds, it can be temporarily stopped by pressing the SNOOZE button. The display will show the relative alarm indicator  or  flashing.
- The alarm will be delayed for 9 minutes and then come again.
- This manual snooze operation can be repeated again within one hour.

## LISTENING TO RADIO

1. Press the  POWER button to turn on the unit.
2. Press the FUNCTION button to select Radio mode.
3. To manually tune the radio station, press the  or  button repeatedly. Use the manual tuning method to tune to weaker stations that are bypassed during Automatic Tuning.
4. To automatically tune to the next radio station with the strongest signal, press and hold the  or  button for 1-2 seconds until frequency readout on the display begins to scan and then release the button. The tuner will stop scanning when it receives the next strongest station signal.
5. Adjust the volume control to the desired volume level.

### **HINTS FOR BEST RECEPTION:**

The receiver has a build-in FM wire antenna hanging from the back cabinet. This wire should be totally unraveled and extended for the best reception.

**NOTE:** Automatic tuning depends on the signal strength of the broadcasting station, so weak stations may be skipped. You can manually tune to find the weak stations if a station gets skipped. With strong signals, the tuner may stop before it reaches the actual broadcast frequency, so you may need to manually tune for the best reception.

### **PRESET RADIO STATIONS**

This unit has 20 preset memories for the FM radio.

1. Press the POWER button to turn on the unit.
2. Press the FUNCTION button to select Radio mode.
3. Tune to the desired radio station either by “manually” or “automatically” tuning method.
4. Press and hold the MEM.SET/CLK.ADJ. button to enable the program function and

- the "P01" indicator will show on the LCD. Preset channel number "01" is flashing.
5. Press the ◀ or ▶ button to select the preset number you want to assign the station to.
  6. Press the MEM.SET/CLK.ADJ. button to confirm the setting.
  7. Repeat above steps 3-6 to store other stations.

### **RECALLING PRESET MEMORY CHANNELS**

In radio mode, recall the pre-set channels by pressing the MEM+ button on main unit repeatedly.

## **LISTENING TO YOUR iPhone/iPod**

### **iPod Bracket**

The JiMS-125i comes with a removable insert bracket for iPod Classic 160GB, but it should also work with other models too. If the included adaptor does not fit your iPod, you can still use the dock without an adaptor or use the original adaptor included with your iPod instead by inserting it into the docking area.





### **Inserting the iPod Bracket**

1. Gently press the iPod insert or your iPod Bracket into the dock if you are use an iPod. No Bracket is required if you use an iPhone.
2. Carefully place your iPhone/iPod into the docking bay by placing the connector on the bottom of the iPhone/iPod onto the connector in the docking bay.

**NOTE:** Remember to remove any bumper of iPhone 4 before inserting it into the docking connector.

3. To remove/replace an Bracket, first remove your iPhone / iPod, then grip the Bracket and pull gently upwards.

### **PLAYBACK**

1. Press the  POWER button to turn on the unit.
2. Press the FUNCTION button to select iPod mode, the iPod "  " icon appears on the LCD display and then press the PLAY/PAUSE  button to start playback.
3. Press the PLAY/PAUSE  button to pause or resume playback.
4. Press the VOLUME+ / - button to adjust your desired volume level

**NOTE:** The volume level cannot be adjusted by the volume control of your iPod after being docked.

5. Press the ◀ or ▶ button to select the desire music track.
6. Press and hold the ◀ or ▶ button for fast-forwarding or fast-rewinding during playback.
7. To remove the iPhone/iPod from the unit, press and hold the PLAY/PAUSE 

button for five seconds to switch off the device and then gently remove it from the docking connector.

8. Press the  POWER button to turn off the unit.

## **CHARGING**

Your iPhone/iPod will charge in all function modes when docked.

**NOTE:** To prevent damaging of the dock connector, never twist the iPhone/iPod when inserting or removing it.

## **DIMMER**

In Standby mode, press the DIMMER button to adjust the LCD backlight intensity from High/Low /Mid to obtain the best clarity of LCD Panel readout.

## **SLEEP TIMER OPERATIONS**

1. In Radio, iPod or AUX mode, press the SLEEP button once, then the “SLP” indicator will appear on the LCD display.
2. Press the SLEEP button repeatedly to select the desired sleep time. The sleep timer can be chosen from 10 - 90 minutes in 10 minute step. After sleep timer selected, wait for 5 seconds to confirm. The “SLP” indicator continues to appear on the LCD. The unit will stop and go into Standby mode automatically after selected sleep time has expired.
3. To check remained sleep time, simply press the SLEEP button.
4. Press the  POWER button once to switch off the unit before the selected sleep time expires.

### **NOTE:**

- If you press the SLEEP button once and the “SLP “ indicator appears on the LCD display, the unit will go into Standby mode automatically after selected time has expired.
- If you are falling asleep to music from an external device connected to AUX input, the sleep timer will shut off the power to this unit but it will not turn off power to the external device.

## **AUXILIARY INPUT**

This unit provides an auxiliary audio signal input jack for connecting external audio devices like MP3 players, CD players and listen to them through the speakers of this unit.

1. Use an audio cable (not included) with one 3.5 mm stereo plug on each end of the cable.
2. Plug one end into the Aux-in jack on the main unit and the other end of the cable into the Line-out Jack or Headphone Jack of your external audio device.

3. Turn on the external audio device.
4. To select auxiliary audio input, press the FUNCTION button to select AUX mode.
5. The volume level can now be controlled through the main unit. Operate all other functions on the auxiliary device as usual.

**NOTE:**

- If you connect this unit to the Line-Out Jack of your external device then you only need to adjust the volume control of this unit. If you connected the Headphone Jack of your external device then you may need to adjust both the volume control of your external device and the volume control of this unit to find the most desirable volume setting.
- Press the  POWER button to turning off the unit when you finish listening. Don't forget to switch off the power of your external device as well.

## RESETTING

If the system does not respond or exhibits erratic or intermittent operation, you may have experienced an electrostatic discharge (ESD) or a power surge that triggered the internal microcontroller to shut down automatically. If this occurs, simply disconnect the AC adaptor and remove the system backup battery, wait for at least 3 minutes and then setup the unit again as if it is a brand new unit.

## CARE AND MAINTENANCE

1. Do not subject the unit to excessive force, shock, dust or extreme temperature.
2. Do not tamper the internal components of the unit.
3. Clean your unit with a dry cloth. Solvent or detergent should never be used.
4. Avoid leaving your unit in direct sunlight or in hot, humid or dusty places.
5. Keep your unit away from heating appliances and sources of electrical noise such as fluorescent lamps or motors.

### CLEANING THE UNIT

- To prevent fire or shock hazard, disconnect your unit from the AC power source when cleaning.
- The finish on the unit may be cleaned with a dust cloth and cared for as other furniture, Use caution when cleaning and wiping the plastic parts.
- If the cabinet becomes dusty wipe it with a soft dry dust cloth. Do not use any wax or polish sprays on the cabinet.
- If the front panel becomes dirty or smudged with fingerprints it may be cleaned with a soft cloth slightly dampened with a mild soap and water solution. Never use abrasive cloths or polishes as these will damage the finish of your unit.

**CAUTION:** Never allow any water or other liquids to get inside the unit while cleaning.

## TROUBLESHOOTING GUIDE

Symptom	Possible Problem	Solution
The unit does not respond (no power)	The unit is disconnected from the AC outlet.	Reconnect to the AC outlet.
	The AC outlet has not power.	Try the unit on another outlet.
Unit is ON but there is low or no volume	The volume control has been turned all the way down.	Turn the Volume control to a higher output.
iPod / iPhone does not dock properly	Using no/wrong iPod / iPhone Adaptor.	Make sure the dock insert is the proper fit for your iPod / iPhone.
	iPod / iPhone not installed properly.	Remove your iPod / iPhone from the dock and check for obstruction on the connectors in the dock and on your iPod / iPhone. Then carefully reseal it in the dock.
iPod / iPhone does not respond to the speaker system	iPod / iPhone is not installed properly.	Remove your iPod / iPhone from the dock and check for obstruction on the connectors in the dock and on your iPod / iPhone. Then carefully reseal it on the dock.
	Your iPod / iPhone is locked up.	Please make sure that your iPod / iPhone is working properly before docking into the unit. Please refer to your iPod / iPhone manual for details.
iPod / iPhone does not charge up	iPod / iPhone is not installed properly.	Remove your iPod / iPhone from the dock and check for obstruction on the connectors in the dock and on your iPod. Then carefully reseal it in the dock.
	iPod / iPhone is locked up or frozen. iPod / iPhone battery has problem.	Please make sure your iPod / iPhone is working properly before docking into the unit. Please refer to your iPod / iPhone manual for details.
Noise or sound distorted on FM broadcast	Station not tuned properly for FM. The FM wire antenna is not fully extended.	Retune the FM broadcast station. Fully extend the FM wire antenna.
Sound is distorted	Volume level is set too high.	Decrease the volume.
	Sound source is distorted.	If the iPod / iPhone original sound source is of poor quality, distortion and noise are easily noticed with high-power speakers. Try a different audio source such as a music CD. If you are using an external sound source like older generation of iPod, try reducing the output volume on the device itself. Also try turning bass boost OFF or change the EQ setting.

Unit gets warm after extended play at high volume	This is normal.	Turn the unit off for a period of time or lower volume.
---	-----------------	---

## SPECIFICATION

### **Power requirement:**

AC-DC adaptor	Input: AC 120V~, 60Hz
<u>Main Unit</u>	DC Input: DC 5V, 2000mA
<u>Backup Battery for Clock</u>	1 X 3V CR2032 Lithium Battery

### **Frequency Range**

<u>Radio Band</u>	FM 87.5 ~ 108 MHz
-------------------	-------------------

"Made for iPod" and "Made for iPhone" mean that an electronic accessory has been designed to connect specifically to iPod and iPhone respectively, and has been certified by the developer to meet Apple performance standards. Apple is not responsible for the operation of this device or its compliance with safety and regulatory standards. Please note that the use of this accessory with iPod or iPhone may affect wireless performance.

iPod, iPod classic, iPod nano, iPod shuffle, and iPod touch are trademarks of Apple Inc., registered in the U.S. and other countries.



At Spectra, environmental and social responsibility is a core value of our business. We are dedicated to continuous implementation of responsible initiatives with an aim to conserve and maintain the environment through responsible recycling.

Please visit us at <http://www.spectraintl.com/green.htm> for more information on Spectra's green initiatives or to find a recycler in your area.

**90 DAY LIMITED WARRANTY AND SERVICE  
VALID IN THE U.S.A ONLY**

SPECTRA MERCHANDISING INTERNATIONAL, INC. warrants this unit to be free from defective materials or factory workmanship for a period of 90 days from the date of original customer purchase and provided the product is utilized within the U.S.A. This warranty is not assignable or transferable. Our obligation under this warranty is the repair or replacement of the defective unit or any part thereof, except batteries, when it is returned to the SPECTRA Service Department, accompanied by proof of the date of original consumer purchase, such as a duplicate copy of a sales receipt.

You must pay all shipping charges required to ship the product to SPECTRA for warranty service. If the product is repaired or replaced under warranty, the return charges will be at SPECTRA's expense. There are no other express warranties other than those stated herein.

This warranty is valid only in accordance with the conditions set forth below:

1. The warranty applies to the SPECTRA product only while:
  - a. It remains in the possession of the original purchaser and proof of purchase is demonstrated.
  - b. It has not been subjected to accident, misuse, abuse, improper service, usage outside the descriptions and warnings covered within the user manual or non-SPECTRA approved modifications.
  - c. Claims are made within the warranty period.
2. This warranty does not cover damage or equipment failure caused by electrical wiring not in compliance with electrical codes or SPECTRA user manual specifications, or failure to provide reasonable care and necessary maintenance as outlined in the user manual.
3. Warranty of all SPECTRA products applies to residential use only and is void when products are used in a nonresidential environment or installed outside the United States.

This warranty gives you specific legal rights, and you may also have other rights which vary from state to state. TO OBTAIN SERVICE please remove all batteries (if any) and pack the unit carefully and send it freight prepaid to SPECTRA at the address shown below. IF THE UNIT IS RETURNED WITHIN THE WARRANTY PERIOD shown above, please include a proof of purchase (dated cash register receipt) so that we may establish your eligibility for warranty service and repair of the unit without cost. Also include a note with a description explaining how the unit is defective. A customer service representative may need to contact you regarding the status of your repair, so please include your name, address, phone number and email address to expedite the process.

IF THE UNIT IS OUTSIDE THE WARRANTY PERIOD, please include a check for \$30.00 to cover the cost of repair, handling and return postage. All out of warranty returns must be sent prepaid.

It is recommended that you contact SPECTRA first at 1-800-777-5331 or by email at [custserv@spectraintl.com](mailto:custserv@spectraintl.com) for updated information on the unit requiring service. In some cases the model you have may be discontinued, and SPECTRA reserves the right to offer alternative options for repair or replacement.

SPECTRA MERCHANDISING INTERNATIONAL, INC.  
4230 North Normandy Avenue,  
Chicago, IL60634, USA.  
1-800-777-5331

To register your product, visit the link on the website below to enter your information.  
<http://www.spectraintl.com/wform.htm>

Printed in China